

# mitsubishi electric

## Air-Conditioners

### INDOOR UNIT

# PE-5, 6, 8, 10, 12, 16, 20 MYE

#### FOR USER

用户适用

GB

#### OPERATION MANUAL

For safe and correct use, please read this operation manual thoroughly before operating the air-conditioner unit.

中

#### 操作手册

为了确保安全和正确使用，请在使用空调器之前仔细阅读本操作手册。



Большая библиотека технической документации  
<http://splitoff.ru/tehn-doc.html>  
каталоги, инструкции, сервисные мануалы, схемы.

2

[Fig. 2.0.1]

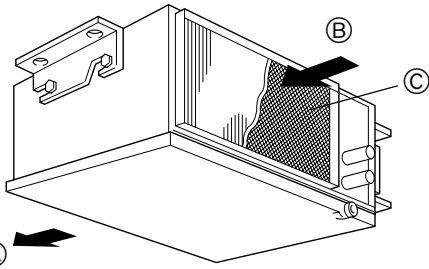

- Ⓐ Air outlet
- Ⓑ Air inlet
- Ⓒ Air filter (optional part)

[Fig. 2.0.2]

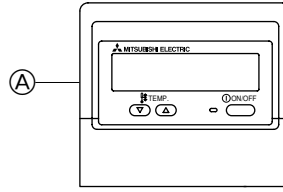

- Ⓐ LCD remote controller (optional part)

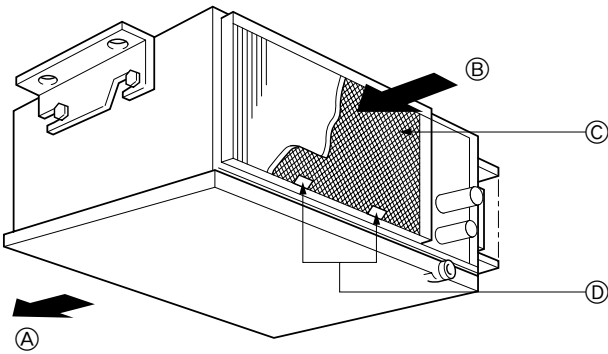

5

[Fig. 5.0.1]



- Ⓐ Air outlet
- Ⓑ Air inlet
- Ⓒ Air filter (optional part)
- Ⓓ Air filter handle

# Contents

|   |   |  |    |
|---|---|--|----|
| 1. Safety precautions .....   | 3 | 3.5. Setting the day of the week and time .....  | 6  |
| 1.1. Installation .....   | 3 | 3.6. Using the timer .....   | 7  |
| 1.2. During operation .....   | 4 | 3.7. Locking the remote controller buttons (Operation function limit controller) ..... | 10 |
| 1.3. Disposing of the unit .....  | 4 | 3.8. Other indications .....   | 10 |
| 2. Names and functions of various parts .....   | 4 | 4. The smart way to use .....  | 11 |
| 3. Operation .....  | 5 | 5. Caring for the machine .....  | 11 |
| 3.1. Switching the unit ON/OFF .....  | 6 | 6. Troubleshooting .....   | 12 |
| 3.2. Mode select .....  | 6 | 7. Installation and transferring works, and checking .....                             | 13 |
| 3.3. Selecting a temperature  TEMP. .... | 6 | 8. Specifications .....  | 13 |
| 3.4. Selecting a fan speed  .....        | 6 |  |    |

## 1. Safety precautions





- ▶ Before operating the unit, make sure you read all the “Safety precautions”.
- ▶ “Safety precautions” lists important points about safety. Please be sure to follow them.

### Symbols used in the text

 **Warning:**  
Describes precautions that should be observed to avoid the risk of injury or death to the user.

 **Caution:**  
Describes precautions that should be observed to prevent damage to the unit.

### Symbols put on the unit

-  : Indicates an action that must be avoided.
-  : Indicates that important instructions must be followed.
-  : Indicates a part which must be grounded.
-  : Beware of electric shock. (This symbol is displayed on the main unit label.)  
<Color: yellow>

 **Warning:**  
Carefully read the labels affixed to the main unit.

### 1.1. Installation

- ▶ After you have read this manual, keep it and the Installation Manual in a safe place for easy reference whenever a question arises. If the unit is going to be operated by another person, make sure that this manual is given to him or her.

-  **Warning:**
- The unit should not be installed by the user. Ask the dealer or an authorized company to install the unit. If the unit is installed improperly, water leakage, electric shock or fire may result.
  - Use only accessories authorized by Mitsubishi Electric and ask your dealer or an authorized company to install them. If accessories are installed improperly, water leakage, electric shock or fire may result.
  - The Installation Manual details the suggested installation method. Any structural alteration necessary for installation must comply with local building code requirements.
  - Never repair the unit or transfer it to another site by yourself. If repair is performed improperly, water leakage, electric shock or fire may result. If you need to have the unit repaired or moved, consult your dealer.
  - The appliance is not intended for use by young children or infirm persons without supervision.
  - Young children should be supervised to ensure that they do not play with the appliance.

### 1) Outdoor unit

-  **Warning:**
- The outdoor unit must be installed on a stable, level surface, in a place where there is no accumulation of snow, leaves or rubbish.
  - Do not stand on, or place any items on the unit. You may fall down or the item may fall, causing injury.

 **Caution:**  
The outdoor unit should be installed in a location where air and noise emitted by the unit will not disturb the neighbours.

### 2) Indoor unit

 **Warning:**  
The indoor unit should be securely installed. If the unit is loosely mounted, it may fall, causing injury.

### 3) Remote controller

 **Warning:**  
The remote controller should be installed in such a way that children cannot play with it.

### 4) Drain hose

 **Caution:**  
Make sure that the drain hose is installed so that drainage can go ahead smoothly. Incorrect installation may result in water leakage, causing damage to furniture.

### 5) Power line, fuse or circuit breaker

-  **Warning:**
- Make sure that the unit is powered by a dedicated line. Other appliances connected to the same line could cause an overload.
  - Make sure that there is a main power switch.
  - Be sure to adhere to the unit's voltage and fuse or circuit breaker ratings. Never use a piece of wire or a fuse with a higher rating than the one specified.

### 6) Grounding

-  **Caution:**
- The unit must be properly grounded. Never connect the grounding wire to a gas pipe, water pipe, lightning conductor or telephone grounding wire. If the unit is not grounded properly, electric shock may result.
  - Check frequently that the ground wire from the outdoor unit is properly connected to both the unit's ground terminal and the grounding electrode.

## 1.2. During operation

### ⚠ Caution:

- Do not use any sharp object to push the buttons, as this may damage the remote controller.
- Do not twist or tug on the remote controller cord as this may damage the remote controller and cause malfunction.
- Never remove the upper case of the remote controller. It is dangerous to remove the upper case of the remote controller and touch the printed circuit boards inside. Doing so can result in fire and failure.
- Never wipe the remote controller with benzene, thinner, chemical rags, etc. Doing so can result in discoloration and failure. To remove heavy stains, soak a cloth in neutral detergent mixed with water, wring it out thoroughly, wipe the stains off, and wipe again with a dry cloth.
- Never block or cover the indoor or outdoor unit's intakes or outlets. Tall items of furniture underneath the indoor unit, or bulky items such as large boxes placed close to the outdoor unit will reduce the unit's efficiency.

### ⚠ Warning:

- Do not splash water over the unit and do not touch the unit with wet hands. An electric shock may result.
- Do not spray combustible gas close to the unit. Fire may result.
- Do not place a gas heater or any other open-flame appliance where it will be exposed to the air discharged from the unit. Incomplete combustion may result.

### ⚠ Warning:

- Do not remove the front panel or the fan guard from the outdoor unit when it is running. You could be injured if you touch rotating, hot or high-voltage parts.
- Never insert fingers, sticks etc. into the intakes or outlets, otherwise injury may result, since the fan inside the unit rotates at high speed. Exercise particular care when children are present.
- If you detect odd smells, stop using the unit, turn off the power switch and consult your dealer. Otherwise, a breakdown, electric shock or fire may result.
- When you notice exceptionally abnormal noise or vibration, stop operation, turn off the power switch, and contact your dealer.
- Do not over-cool. The most suitable inside temperature is one that is within 5 °C of the outside temperature.
- Do not leave handicapped people or infants sitting or standing in the path of the airflow from the air-conditioner. This could cause health problems.

### ⚠ Caution:

- Do not direct the airflow at plants or caged pets.
- Ventilate the room frequently. If the unit is operated continuously in a closed room for a long period of time, the air will become stale.

## 2. Names and functions of various parts

### Indoor unit

- Air inlet: Return the indoor air.
- Filter: Air filter is not provided within the unit. However, simple filter is available as optional part to remove visible dust and dirt. If air purification is one of the conditions required for use, consult with your dealer. (For details on how to clean, refer to page 11.)
- Air outlet: Blow the cooled air into the room.

Model PE-5, 6, 8, 10, 12, 16, 20

[Ceiling concealed type]

[Fig. 2.0.1] (P.2)

Ⓐ Air outlet

Ⓑ Air inlet

Ⓒ Air filter (optional part)

### In case of failure

#### ⚠ Warning:

- Never remodel the air conditioner. Consult your dealer for any repair service. Improper repair work can result in water leakage, electric shock, fire, etc.
- If the remote controller displays an error indication, the air conditioner does not run, or there is any abnormality, stop operation and contact your dealer. Leaving the unit as it is under such conditions can result in fire or failure.
- If the power breaker is frequently activated, get in touch with your dealer. Leaving it as it is can result in fire or failure.
- If the refrigeration gas blows out or leaks, stop the operation of the air conditioner, thoroughly ventilate the room, and contact your dealer. Leaving the unit as it is can result in accidents due to oxygen deficiency.

### When the air conditioner is not to be used for a long time

- If the air conditioner is not to be used for a long time due to a seasonal change, etc., run it for 4 - 5 hours with the air blowing until the inside is completely dry. Failing to do so can result in the growth of unhygienic, unhealthy mold in scattered areas throughout the room.
- When it is not to be used for an extended time, keep the [power supply] turned OFF.  
If the power supply is kept on, several watts or several tens of watts will be wasted. Also, the accumulation of dust, etc., can result in fire.
- Keep the power switched ON for more than 12 hours before starting operation. Do not turn the power supply OFF during seasons of heavy use. Doing so can result in failure.

## 1.3. Disposing of the unit

### ⚠ Warning:

When you need to dispose of the unit, consult your dealer. If pipes are removed incorrectly, refrigerant (fluorocarbon gas) may blow out and come into contact with your skin, causing injury. Releasing refrigerant into the atmosphere also damages the environment.

### LCD remote Controller

- Check out your remote controller.  
Different controllers are used for different systems.

[Fig. 2.0.2] (P.2)

Ⓐ LCD remote controller (optional part)

### 3. Operation

- In case of using LCD remote controller (optional part), refer this operation manual or remote controller operation manual to operate the unit.
- In case of using switch box controller (field supply), please consult dealer for operating method.

#### Remote controller-Button

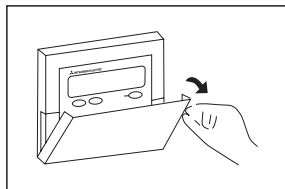

Opening the door.

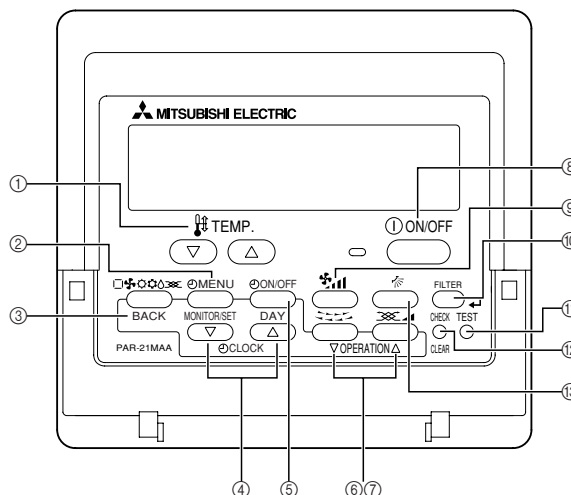

- ① Set Temperature buttons  
 ▾ Down  
 ▴ Up
- ② Timer Menu button (Monitor/Set button)
- ③ Mode button (Return button)
- ④ Set Time buttons  
 ▾ Back  
 ▴ Ahead
- ⑤ Timer On/Off button (Set Day button)
- ⑥ Louver button ( ▾ Operation button)  
 ▾ To preceding operation number.
- ⑦ Ventilation button ( ▴ Operation button)  
 ▴ To next operation number.
- ⑧ ON/OFF button
- ⑨ Fan Speed button

- ⑩ Filter button (<Enter> button)
- ⑪ Test Run button
- ⑫ Check button (Clear button)
- ⑬ Airflow Up/Down button

#### Notes:

- If you press a button for a feature that is not installed at the indoor unit, the remote controller will display the "Not Available" message.
- If you are using the remote controller to drive multiple indoor units, this message will appear only if the feature is not present at the parent unit.
- Never expose the remote controller to direct sunlight. Doing so can result in the erroneous measurement of room temperature.
- Never place any obstacle around the lower right-hand section of the remote controller. Doing so can result in the erroneous measurement of room temperature.

#### Remote controller-Display

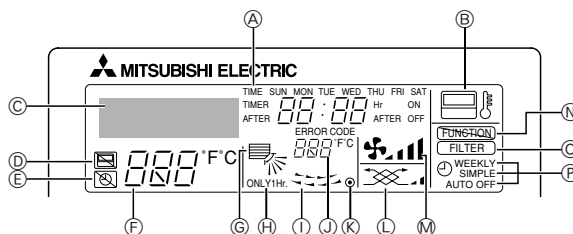

- A Day-of-Week**  
Shows the current day of the week.
- Time/Timer Display**  
Shows the current time, unless the simple or Auto Off timer is set. If the simple or Auto Off timer is set, shows the time remaining.
- B "Sensor" indication**  
Displayed when the remote controller sensor is used.
- C Identifies the current operation**  
Shows the operating mode, etc.  
\* Multilanguage display is supported.
- D "Centrally Controlled" indicator**  
Indicates that operation of the remote controller has been prohibited by a main controller.
- E "Timer Is Off" indicator**  
Indicates that the timer is off.
- F Temperature Setting**  
Shows the target temperature.
- G Up/Down Air Direction indicator**  
The indicator ↘ shows the direction of the outgoing airflow.
- H "One Hour Only" indicator**  
Displayed if the airflow is set to weak and downward during COOL or DRY mode. (Operation varies according to model.)  
The indicator goes off after one hour, at which time the airflow direction also changes.
- I Louver display**  
Indicates the action of the swing louver. Does not appear if the louver is stationary.
- J Room Temperature display**  
Shows the room temperature.
- K ● (Power On indicator)**  
Indicates that the power is on.
- L Ventilation indicator**  
Appears when the unit is running in Ventilation mode.
- M Fan Speed indicator**  
Shows the selected fan speed.
- N "Locked" indicator**  
Indicates that remote controller buttons have been locked.
- O "Clean The Filter" indicator**  
Comes on when it is time to clean the filter.
- P Timer indicators**  
The indicator comes on if the corresponding timer is set.

#### Note:

- For purposes of this explanation, all parts of the display are shown as lit. During actual operation, only the relevant items will be lit.

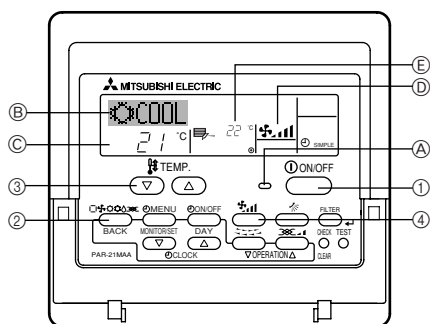

### Before starting operation

- Start running after the "PLEASE WAIT" display has disappeared. The "PLEASE WAIT" display briefly appears on the (B) display (max. 3 minutes) when the power is turned on and after a power failure. This does not indicate any failure of the air conditioner.

### 3.1. Switching the unit ON/OFF

#### ► To start an operation:

- Press the ON/OFF button (1).  
The ON indicator (A) should light up.

#### ► To stop an operation:

- Press the ON/OFF button (1) again.  
The ON indicator (A) goes off.

- The power supply should not be turned off while the air conditioner is in use. This can cause the unit to break down.
- Even if you press the ON/OFF button immediately after shutting down the operation in progress, the air conditioner will not start for about three minutes. This is to prevent the internal components from being damaged.
- If the operation stops due to a power failure, the unit will not automatically restart until the power has been restored. Press the ON/OFF button to restart.

### 3.2. Mode select

- If the unit is off, press the ON/OFF button (1) to turn it on.  
The ON indicator (A) should light up.
- Press the operation mode (2) button and select the operation mode.

- (B) → (COOL) Cooling mode  
→ (FAN) Fan mode

#### For cooling

Press the (2) [operation mode] button and bring up the "COOL" display.

#### For fan

Press the (2) [operation mode] button and bring up the "FAN" display.

- The fan operation functions to circulate the air in the room.
- The temperature of the room cannot be set by fan operation.

#### ⚠ Caution:

Never expose your body directly to cool air for a long time. Excessive exposure to cool air is bad for your health, and should therefore be avoided.

#### ⚠ Caution:

- When the air conditioner is used together with burners, thoroughly ventilate the area. Insufficient ventilation can result in accidents due to oxygen deficiency.
- Never place a burner at a place where it is exposed to the airflow from the air conditioner.  
Doing so can result in imperfect combustion of the burner.

### 3.3. Selecting a temperature

#### ► To decrease the room temperature:

- Press (3) button to set the desired temperature.

The selected temperature (C) is displayed.

- Each time you press the button, the temperature value decreases by 1 °C.

#### ► To increase the room temperature:

- Press (3) button to set the desired temperature.

The selected temperature (C) is displayed.

- Each time you press the button, the temperature value increases by 1 °C.
- Available temperature ranges are as follows:  
Cooling: 19 - 30 °C
- The display flashes either 8 °C - 39 °C to inform you if the room temperature (E) is lower or higher than the displayed temperature. If the temperature is below 8 °C or above 39 °C, the corresponding value (8 °C or 39 °C) will blink on the display.

### 3.4. Selecting a fan speed

- Press (4) button to select a desired fan speed.

- Each time you press the button, available options change with the display (D) on the remote controller, as shown below.

| Model              | Fan speed | Remote controller display |      |
|--------------------|-----------|---------------------------|------|
|                    |           | Low                       | High |
| PE-5, 6, 8, 10, 12 | 2-stage   |                           |      |
| PE-16, 20          | 1-stage   | No display                |      |

### 3.5. Setting the day of the week and time

- Use this screen to change the current day of the week and time setting.

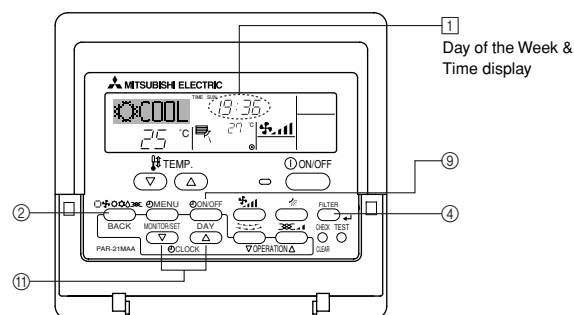

**Notes:**

- It can be set regardless of the operation of the indoor unit.
- The day and time will not appear if clock use has been disabled at Function Selection of remote controller, refer to Installation Manual.

► **How to Set the Day of the Week and Time...**

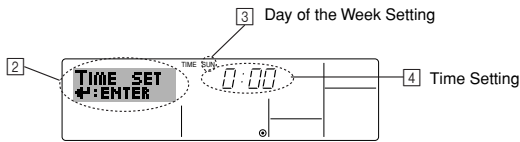

1. Press the  $\nabla$  or  $\Delta$  Set Time button ⑪ to show display ②.
2. Press the Timer On/Off (Set Day) button ⑨ to set the day.  
\* Each press advances the day shown at ③ : Sun → Mon → ... → Fri → Sat.
3. Press the appropriate Set Time button ⑪ as necessary to set the time.  
\* As you hold the button down, the time (at ④) will increment first in minute intervals, then in ten-minute intervals, and then in one-hour intervals.
4. After making the appropriate settings at Steps 2 and 3, press the Filter button ④ to lock in the values.

**Note:**

- Your new entries at Steps 2 and 3 will be cancelled if you press the Mode (Return) button ② before pressing the Filter button ④.

5. Press the Mode (Return) button ② to complete the setting procedure. This will return the display to the standard control screen, where ① will now show the newly set day and time.

**Note:**

- Remote controller is equipped with a simplified clock with a precision of about + or - one minute per month.

### 3.6. Using the timer

This section explains how to set and use the timer. You can use Function Selection of remote controller to select which of three types of timer to use: ① Weekly timer, ② Simple timer, or ③ Auto Off timer. For information about how to set the Function Selection of remote controller, refer to Installation Manual.

#### 3.6.1. Using the Weekly Timer

- The weekly timer can be used to set up to eight operations for each day of the week.
  - Each operation may consist of any of the following: ON/OFF time together with a temperature setting, or ON/OFF time only, or temperature setting only.
  - When the current time reaches a time set at this timer, the air conditioner carries out the action set by the timer.
- Time setting resolution for this timer is 1 minute.

**Notes:**

- \*1. Weekly Timer/Simple Timer/Auto Off Timer cannot be used at the same time.
- \*2. The weekly timer will not operate when any of the following conditions is in effect.

The timer feature is off; the system is in a malfunction state; a test run is in progress; the remote controller is undergoing self-check or remote controller check; the user is in the process of setting a function; the user is in the process of setting the timer; the user is in the process of setting the current day of the week or time; the system is under central control. (Specifically, the system will not carry out operations (unit on, unit off, or temperature setting) that are prohibited during these conditions.)

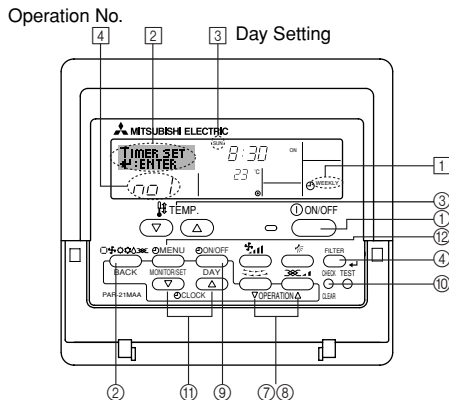

► **How to Set the Weekly Timer**

1. Be sure that you are at a standard control screen, and that the weekly timer indicator ① is shown in the display.
2. Press the Timer Menu button ②, so that the "Set Up" appears on the screen (at ②).  
(Note that each press of the button toggles the display between "Set Up" and "Monitor".)
3. Press the Timer On/Off (Set Day) button ⑨ to set the day. Each press advances the display at ③ to the next setting, in the following sequence: "Sun Mon Tues Wed Thurs Fri Sat" → "Sun" → ... → "Fri" → "Sat" → "Sun Mon Tues Wed Thurs Fri Sat"...
4. Press the  $\nabla$  or  $\Delta$  Operation button (⑦ or ⑧) as necessary to select the appropriate operation number (1 to 8) ④.  
\* Your inputs at Steps 3 and 4 will select one of the cells from the matrix illustrated below. (The remote-controller display at left shows how the display would appear when setting Operation 1 for Sunday to the values indicated below.)

**Setup Matrix**

| Op No. | Sunday                    | Monday           | ...              | Saturday         |
|--------|---------------------------|------------------|------------------|------------------|
| No. 1  | • 8:30<br>• ON<br>• 23 °C |                  |                  |                  |
| No. 2  | • 10:00<br>• OFF          | • 10:00<br>• OFF | • 10:00<br>• OFF | • 10:00<br>• OFF |
| ...    |                           |                  |                  |                  |
| No. 8  |                           |                  |                  |                  |

<Operation 1 settings for Sunday>  
Start the air conditioner at 8:30, with the temperature set to 23 °C.

<Operation 2 settings for every day>  
Turn off the air conditioner at 10:00.

**Note:**

By setting the day to "Sun Mon Tues Wed Thurs Fri Sat", you can set the same operation to be carried out at the same time every day. (Example: Operation 2 above, which is the same for all days of the week.)

► **Setting the Weekly Timer**

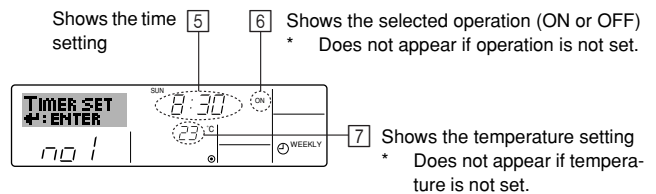

5. Press the appropriate Set Time button ⑪ as necessary to set the desired time (at ⑤).  
\* As you hold the button down, the time first increments in minute intervals, then in ten-minute intervals, and then in one-hour intervals.
6. Press the ON/OFF button ① to select the desired operation (ON or OFF), at ⑥.  
\* Each press changes the next setting, in the following sequence: No display (no setting) → "ON" → "OFF"
7. Press the appropriate Set Temperature button ③ to set the desired temperature (at ⑦).  
\* Each press changes the setting, in the following sequence: No display (no setting) ⇔ 24 ⇔ 25 ⇔ ... ⇔ 29 ⇔ 30 ⇔ 12 ⇔ ... ⇔ 23 ⇔ No display. (Available range: The range for the setting is 12 °C to 30 °C. The actual range over which the temperature can be controlled, however, will vary according to the type of the connected unit.)
8. After making the appropriate settings at Steps 5, 6 and 7, press the Filter button ④ to lock in the values.  
To clear the currently set values for the selected operation, press and quickly release the Check (Clear) button ① once.  
\* The displayed time setting will change to "—:—", and the On/Off and temperature settings will all disappear.  
(To clear all weekly timer settings at once, hold down the Check (Clear) button ① for two seconds or more. The display will begin flashing, indicating that all settings have been cleared.)

CB



**Note:**

Your new entries will be cancelled if you press the Mode (Return) button ② before pressing the Filter button ④.

If you have set two or more different operations for exactly the same time, only the operation with the highest Operation No. will be carried out.

9. Repeat Steps 3 to 8 as necessary to fill as many of the available cells as you wish.
10. Press the mode (Return) button ② to return to the standard control screen and complete the setting procedure.
11. To activate the timer, press the Timer On/Off button ⑨, so that the "Timer Off" indication disappears from the screen. **Be sure that the "Timer Off" indication is no longer displayed.**
  - \* If there are no timer settings, the "Timer Off" indication will flash on the screen.

► **How to View the Weekly Timer Settings**

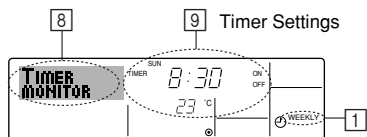

1. Be sure that the weekly timer indicator is visible on the screen (at ①).
2. Press the Timer Menu button ⑫ so that "Monitor" is indicated on the screen (at ②).
3. Press the Timer On/Off (Set Day) button ⑨ as necessary to select the day you wish to view.
4. Press the (V) or (A) Operation button (⑦ or ⑧) as necessary to change the timer operation shown on the display (at ③).
- \* Each press will advance to the next timer operation, in order of time setting.
5. To close the monitor and return to the standard control screen, press the Mode (Return) button ②.

► **To Turn Off the Weekly Timer**

Press the Timer On/Off button ⑨ so that "Timer Off" appears at ⑩.

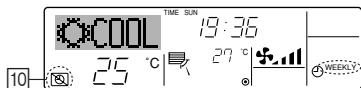

► **To Turn On the Weekly Timer**

Press the Timer On/Off button ⑨ so that the "Timer Off" indication (at ⑩) goes dark.

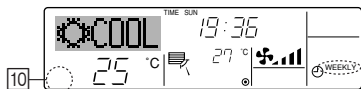

**3.6.2. Using the Simple Timer**

- You can set the simple timer in any of three ways.
  - Start time only: The air conditioner starts when the set time has elapsed.
  - Stop time only: The air conditioner stops when the set time has elapsed.
  - Start & stop times: The air conditioner starts and stops at the respective elapsed times.
- The simple timer (start and stop) can be set only once within a 72-hour period. The time setting is made in hour increments.

**Notes:**

- \*1. Weekly Timer/Simple Timer/Auto Off Timer cannot be used at the same time.
- \*2. The simple timer will not operate when any of the following conditions is in effect.
  - The timer is off; the system is in malfunction state; a test run is in progress; the remote controller is undergoing self-check or remote controller check; the user is in the process of selecting a function; the user is in the process of setting the timer; the system is under central control. (Under these conditions, On/Off operation is prohibited.)

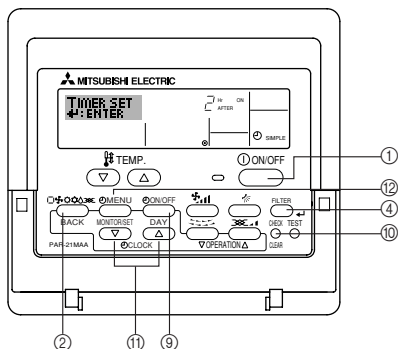

► **How to Set the Simple Timer**

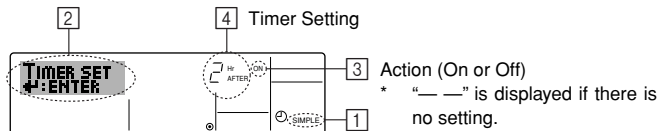

1. Be sure that you are at a standard control screen, and that the simple timer indicator is visible in the display (at ①). When something other than the Simple Timer is displayed, set it to SIMPLE TIMER using the function selection of remote controller (see Installation Manual).
2. Press the Timer Menu button ⑫, so that the "Set Up" appears on the screen (at ②). (Note that each press of the button toggles the display between "Set Up" and "Monitor".)
3. Press the ON/OFF button ① to display the current ON or OFF simple timer setting. Press the button once to display the time remaining to ON, and then again to display the time remaining to OFF. (The ON/OFF indication appears at ③).
  - "ON" timer: The air conditioner will start operation when the specified number of hours has elapsed.
  - "OFF" timer: The air conditioner will stop operation when the specified number of hours has elapsed.
4. With "ON" or "OFF" showing at ③: Press the appropriate Set Time button ⑪ as necessary to set the hours to ON (if "ON" is displayed) or the hours to OFF (if "OFF" is displayed) at ④.
  - Available Range: 1 to 72 hours
5. To set both the ON and OFF times, repeat Steps 3 and 4.
  - \* Note that ON and OFF times cannot be set to the same value.
6. To clear the current ON or OFF setting: Display the ON or OFF setting (see step 3) and then press the Check (Clear) button ⑩ so that the time setting clears to "—" at ④. (If you want to use only an ON setting or only an OFF setting, be sure that the setting you do not wish to use is shown as "—".)
7. After completing steps 3 to 6 above, press the Filter button ④ to lock in the value.

**Note:**

Your new settings will be cancelled if you press the Mode (Return) button ② before pressing the Filter button ④.

8. Press the Mode (Return) button ② to return to the standard control screen.
9. Press the Timer On/Off button ⑨ to start the timer countdown. When the timer is running, the timer value is visible on the display. **Be sure that the timer value is visible and appropriate.**

► **Viewing the Current Simple Timer Settings**

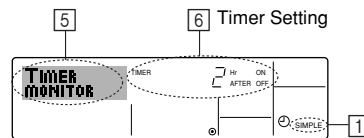

1. Be sure that the simple timer indicator is visible on the screen (at ①).
2. Press the Timer Menu button ⑫, so that the "Monitor" appears on the screen (at ⑤).
  - If the ON or OFF simple timer is running, the current timer value will appear at ⑥.
  - If ON and OFF values have both been set, the two values appear alternately.
3. Press the Mode (Return) button ② to close the monitor display and return to the standard control screen.

► **To Turn Off the Simple Timer...**

Press the Timer On/Off button ⑨ so that the timer setting no longer appears on the screen (at ⑦).

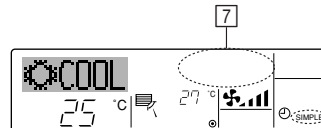

► **To Turn On the Simple Timer...**

Press the Timer On/Off button ⑨ so that the timer setting becomes visible at ⑦.

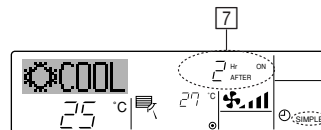



### Examples

If ON and OFF times have both been set at the simple timer, operation and display are as indicated below.

#### Example 1:

Start the timer, with ON time set sooner than OFF time

ON Setting: 3 hours

OFF Setting: 7 hours

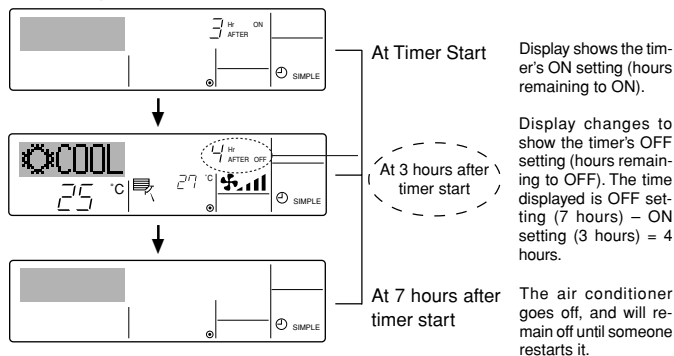

#### Example 2:

Start the timer, with OFF time is sooner than ON time

ON Setting: 5 hours

OFF Setting: 2 hours

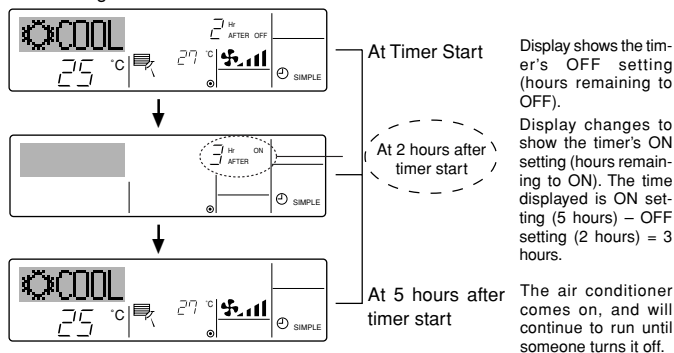

### 3.6.3. Using the Auto Off Timer

- This timer begins countdown when the air conditioner starts, and shuts the air conditioner off when the set time has elapsed.
- Available settings run from 30 minutes to 4 hours, in 30-minute intervals.

#### Notes:

- \*1. Weekly Timer/Simple Timer/Auto Off Timer cannot be used at the same time.
- \*2. The Auto Off timer will not operate when any of the following conditions is in effect.  
The timer is off; the system is in malfunction state; a test run is in progress; the remote controller is undergoing self-check or remote controller check; the user is in the process of selecting a function; the user is in the process of setting the timer; the system is under central control. (Under these conditions, On/Off operation is prohibited.)

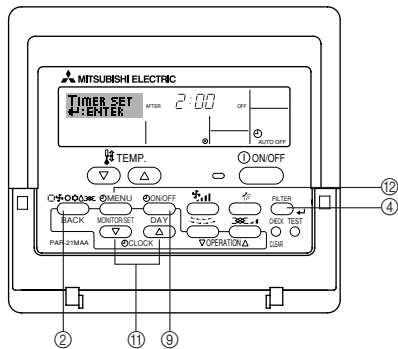

#### ► How to Set the Auto Off Timer

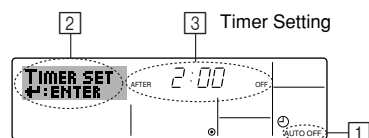

1. Be sure that you are at a standard control screen, and that the Auto Off timer indicator is visible in the display (at [1]).

When something other than the Auto Off Timer is displayed, set it to AUTO OFF TIMER using the function selection of remote controller (see Installation Manual).

2. Hold down the Timer Menu button [2] for 3 seconds, so that the "Set Up" appears on the screen (at [2]).  
(Note that each press of the button toggles the display between "Set Up" and "Monitor".)
3. Press the appropriate Set Time button [3] as necessary to set the OFF time (at [3]).
4. Press the Filter button [4] to lock in the setting.

#### Note:

Your entry will be cancelled if you press the Mode (Return) button [2] before pressing the Filter button [4].

5. Press the Mode (Return) button [2] to complete the setting procedure and return to the standard control screen.
6. If the air conditioner is already running, the timer starts countdown immediately. **Be sure to check that the timer setting appears correctly on the display.**

#### ► Checking the Current Auto Off Timer Setting

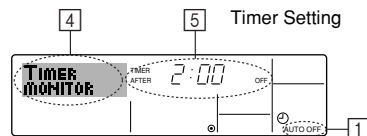

1. Be sure that the "Auto Off" is visible on the screen (at [1]).
2. Hold down the Timer Menu button [2] for 3 seconds, so that "Monitor" is indicated on the screen (at [4]).  
• The timer remaining to shutdown appears at [5].
3. To close the monitor and return to the standard control screen, press the Mode (Return) button [2].

#### ► To Turn Off the Auto Off Timer...

- Hold down the Timer On/Off button [9] for 3 seconds, so that "Timer Off" appears (at [6]) and the timer value (at [7]) disappears.

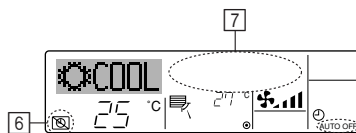

- Alternatively, turn off the air conditioner itself. The timer value (at [7]) will disappear from the screen.

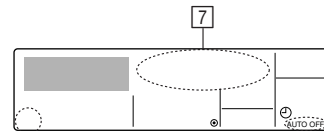

#### ► To Turn On the Auto Off Timer...

- Hold down the Timer On/Off button [9] for 3 seconds. The "Timer Off" indication disappears (at [6]), and the timer setting comes on the display (at [7]).
- Alternatively, turn on the air conditioner. The timer value will appear at [7].

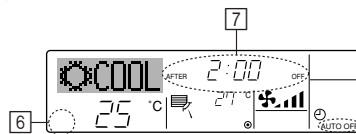

### 3.7. Locking the remote controller buttons (Operation function limit controller)

■ If you wish, you can lock the remote controller buttons. You can use the Function Selection of remote controller to select which type of lock to use. (For information about selecting the lock type, see Installation Manual). Specifically, you can use either of the following two lock types.

- ① Lock All Buttons:  
Locks all of the buttons on the remote controller.
- ② Lock All Except ON/OFF:  
Locks all buttons other than the ON/OFF button.

**Note:**

The “Locked” indicator appears on the screen to indicate that buttons are currently locked.

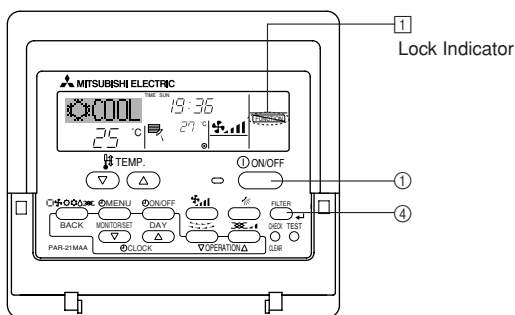

► **How to Lock the Buttons**

- While holding down the Filter button ④, press and hold down the ON/OFF button ① for 2 seconds. The “Locked” indication appears on the screen (at ①), indicating that the lock is now engaged.  
\* If locking has been disabled in Function Selection of remote controller, the screen will display the “Not Available” message when you press the buttons as described above.



- If you press a locked button, the “Locked” indication (at ①) will blink on the display.



► **How to Unlock the Buttons**

- While holding down the Filter button ④, press and hold down the ON/OFF button ① for 2 seconds—so that the “Locked” indication disappears from the screen (at ①).



### 3.8. Other indications

#### 3.8.1. Centrally Controlled

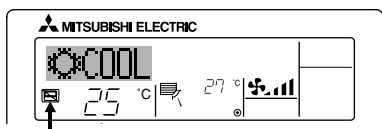

- Displayed when operation is controlled by central controller, etc. Restricted operations are shown below.
  - ON/OFF (including timer operation)
  - Operation mode
  - Set temperature

**Note:**

May also be individually restricted.

#### 3.8.2. Flashing Mode Indicator

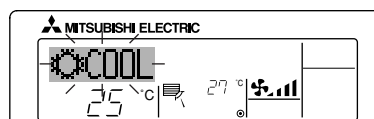

- When flashes continuously  
Displayed when another indoor unit connected to the outdoor unit is already operating in a different operation mode. Match with the operation mode of the other indoor unit.
- When mode switched after display flashes  
Displayed when operation mode is restricted for each season by central controller, etc. Use another operation mode.

#### 3.8.3. Flashing “Filter”

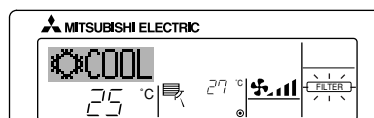

- Indicates that the filter needs cleaning. Clean the filter.
- When resetting “FILTER” display  
When the [FILTER] button is pressed two times successively after cleaning the filter, the display goes off and is reset.

#### 3.8.4. Flashing Error Codes

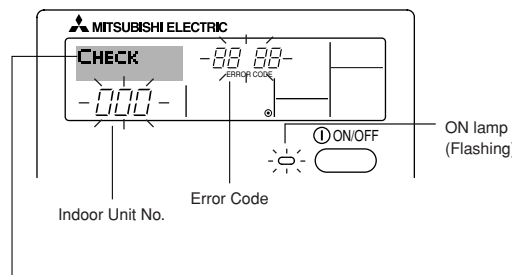

If you have entered contact number to be called in the event of a problem, the screen displays this number. (You can set this up under Function Selection of remote controller. For information, refer to Installation Manual.)

- If the ON lamp and error code are both flashing: This means that the air conditioner is out of order and operation has been stopped (and cannot resume). Take note of the indicated unit number and error code, then switch off the power to the air conditioner and call your dealer or servicer.

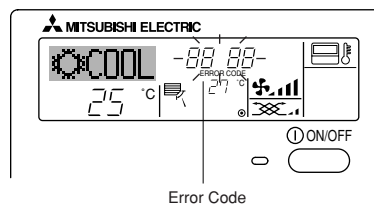

- If only the error code is flashing (while the ON lamp remains lit): Operation is continuing, but there may be a problem with the system. In this case, you should note down the error code and then call your dealer or servicer for advice.

\* If you have entered contact number to be called in the event of a problem, push the Check button to display it on the screen. (You can set this up under Function Selection of remote controller. For information, refer to Installation Manual)

When the Check button is pressed:

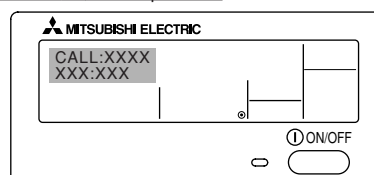

## 4. The smart way to use

Even minimal steps to care for your air conditioner can help make its use far more effective in terms of air-conditioning effect, electricity charges, etc.

### Set the right room temperature

- In cooling operation, a temperature difference of about 5 °C between indoors and outdoors is optimum.
- If the room temperature is raised by 1 °C during air-cooling operation, about 10 % electric power can be saved.
- Excessive cooling is bad for health. It also results in the waste of electric power.

### Clean the filter thoroughly

- Air filter is not provided within the unit, however filter (optional part) must be installed in the return air.
- If the screen of the air filter becomes clogged, the airflow and air-conditioning effect can be significantly reduced. Further, if the condition is left unattended, failure can result. It is particularly important to clean the filter at the beginning of the cooling and heating seasons. (When profuse dust and dirt have accumulated, clean the filter thoroughly.)

## 5. Caring for the machine

Always have filter maintenance performed by a service person.  
Before care-taking, turn the power supply OFF.

### ⚠ Caution:

- Before you start cleaning, stop operation and turn OFF the power supply. Remember that the fan is rotating inside at high speed, posing a serious risk of injury.
- Indoor units are not equipped with filters. However, filter (optional part) must be installed in the return air to remove the dust of sucked-in air. (The standard filter should normally be cleaned once a week, and the long-life filter at the beginning of each season.)

### How to clean

- Clear dust away lightly or clean it up with a vacuum cleaner. In the case of severe staining, wash the filter in lukewarm water mixed with dissolved neutral detergent or water, and then rinse off the detergent completely. After washing, dry it and fix it back into place.

### ⚠ Caution:

- Do not dry the filter by exposing it to direct sunlight or warming it using fire, etc. Doing so can result in the deformation of the filter.
- Washing it in hot water (more than 50 degree C) can also result in deformation.

### Prevent intrusion of heat during air-cooling

- To prevent the intrusion of heat during cooling operation, provide a curtain or a blind on the window to block out direct sunlight. Also, do not open the entrance or exit except in cases of dire necessity.

### Carry out ventilation sometimes

- Since the air periodically gets dirty in a room that is kept closed for a long time, ventilation is sometimes necessary. When gas appliances are used together with the air conditioner, special precautions must be taken. If the "LOSSNAY" ventilation unit developed by our company is used, you can perform ventilation with less waste. For details on this unit, consult with your dealer.

### ⚠ Caution:

Never pour water or flammable sprays onto the air conditioner. Cleaning using these methods can result in the failure of the air conditioner, electric shock, or fire.

### Replacement of filter





[Fig. 5.0.1] (P.2)

- Ⓐ Air outlet
- Ⓑ Air inlet
- Ⓒ Air filter (optional part)
- Ⓓ Air filter handle

- (1) The air filter (optional part) should be located at the air inlet (rear side of the unit).
- (2) Lift the air filter handles and pull the filter towards you.
- (3) If you are going to use an air inlet conduit, remove the air filter. In this case, an air filter must be prepared locally and installed at the intake grille.

## 6. Troubleshooting

Before you call out a repair man, check the following table to see whether there is a simple solution to your problem.

- **Unit does not cool very well.**
  - Clean the filter. (Dust and debris that collects in the filter will decrease air-flow.)
  - Check the temperature setting and adjust it if necessary.
  - Increase the space surrounding the outdoor unit.
    - Is the air intake or air outlet blocked?
    - Is a window or door open?
- **There is a “swishing” noise that occurs from the unit when water flows.**
  - This sound is made when refrigerant inside of the unit is flowing or refilling.
- **A ticking noise is heard from inside of the unit.**
  - This sound is made when internal parts of the unit expand or contract when the temperature changes.
- **An odor is detected in the room.**
  - This is caused when the unit expels odors that have been absorbed from the walls, carpets, furniture or clothing.
- **A white mist is expelled from the indoor unit.**
  - This may occur just after the unit is turned on when a high level of humidity is present in the room.
- **Water or moisture is expelled from the outdoor unit.**
  - This occurs to expel water or moisture that may have collected in the pipes or around piping fixtures.
  - This occurs to dispel water from the heat exchanger.
- **The indicators of the remote controller do not light up when operated.**
  - Turn on the power switch. “” will be displayed.
- ** indicator is displayed in the remote controller.**
  - The start and stop or operation mode or set temperature functions of the remote controller are not available when the  indicator is lit.
- **The start and stop functions are not available just after restarting the unit.**
  - Wait about three minutes (operation has stopped to prevent damage to the air conditioner).
- **Unit does not start immediately.**
  - Wait until the unit restarts automatically. The compressor may hesitate re-suming because a three-minute resume prevention circuit is incorporated in the outdoor unit for protection of the compressor.
- **The unit started even though the start/stop button was not pushed.**
  - Is the timer on?
    - Press the start/stop button to stop the unit.
  - Was a distant command sent from the remote controller?
    - Find out if the remote controller was used.
  - Is the  indicator lit?
    - Find out if the remote controller was used.
- **The unit stopped even though the start/stop button was not pushed.**
  - Is the timer on?
    - Press the start/stop button to restart the unit.
  - Was a distant command sent from the remote controller?
    - Find out if the remote controller was used.
  - Is the  indicator lit?
    - Find out if the remote controller was used.
- **“PLEASE WAIT” is displayed in the remote controller.**
  - An automatic startup test is being performed (will last for about two minutes).
- **An error code is displayed in the remote controller.**
  - A self-diagnostic function is being performed to preserve the air conditioner.
    - \* Do not attempt to make repairs yourself. Turn the main switch off and contact the dealer from whom you bought the air conditioner. Provide him or her with the name of the unit and the information displayed in the remote controller.

If none of the above apply, turn the main switch off and contact the dealer from whom you bought the air-conditioner, telling him the model name and the nature of the problem. Do not try to fix the unit yourself.

**In any of the following cases, turn off the main power switch and contact your local dealer for service:**

- The operation lamp (on the main unit) flashes.
- The switches do not work properly.
- The circuit breaker trips frequently (or the fuse blows frequently).
- Water has accidentally been splashed into the unit.
- Water leaks from the unit.
- Something is accidentally dropped into the air-conditioner.
- An unusual noise is heard during operation.

**The following do not indicate any malfunction:**

Odours: smells such as tobacco or cosmetic odours may persist after they have been sucked into the unit.

Sound of liquid flowing inside indoor unit: this can occur during or after operation and is simply the sound of refrigerant being circulated inside the unit.

Ticking sound coming from indoor unit: this can occur when cooling has just begun or has just stopped. It is caused by the indoor unit shrinking or expanding slightly due to the change in temperature.

**NOTE: The refrigerant charged in the air conditioner is safe. Refrigerant normally does not leak, however, if refrigerant gas leaks indoors, and comes into contact with the fire of a fan heater, space heater, stove, etc., harmful substances will be generated.**

**Be sure to ask the service representative whether there is refrigerant leakage or not when repairs are carried out.**

## 7. Installation and transferring works, and checking

### Regarding place for installation

Consult with your dealer for details on installation and transferring the installation.

#### ⚠ Caution:

**Never install the air conditioner where there is a risk of leakage of flammable gas.**

**If gas leaks and accumulates around the unit, fire can result.**

#### Never install the air conditioner at the following place:

- where there is much machine oil
- near ocean and beach areas where there is much salt
- where humidity is high
- where there are hot springs nearby
- where there is much sulfureted gas
- where there is a high-frequency processing machinery (a high-frequency welder, etc.)
- where acid solution is frequently used
- where special sprays are frequently used
- Install the indoor unit horizontally. Otherwise, water leakage can result.
- Take sufficient measures against noise when installing the air conditioners at hospitals or communication-related businesses.

If the air conditioner is used in any of the above-mentioned environments, frequent operational failure can be expected. It is advisable to avoid these types of installation sites.

For further details, consult with your dealer.

### Regarding electrical work

#### ⚠ Caution:

- **The electrical work must be undertaken by a person who is qualified as an electric engineer according to local regulations and the instruction given in the installation manual with the absolute use of exclusive circuits. The use of other products with the power source can result in burnt-out breakers and fuses.**
- **Never connect the grounding wire to a gas pipe, water pipe, arrester, or telephone grounding wire. For details, consult with your dealer.**
- **In some types of installation sites, the installation of an earth leakage breaker is mandatory. For details, consult with your dealer.**

### Regarding transfer of installation

- When removing and reinstalling the air conditioner when you enlarge your home, remodel, or move, consult with your dealer in advance to ascertain the cost of the professional engineering work required for transferring the installation.

#### ⚠ Caution:

**When moving or reinstalling the air conditioner, consult with your dealer. Defective installation can result in electric shock, fire, etc.**

### Regarding noise

- In installing work, choose a place that can fully bear the weight of the air conditioner, and where noise and vibration can be reduced.
- Choose a place where cool or warm air and noise from the outdoor air outlet of the air conditioner do not inconvenience the neighbours.
- If any alien object is placed near the outdoor air outlet of the air conditioner, decreased performance and increased noise can result. Avoid placing any obstacles adjacent to the air outlet.
- If the air conditioner produces any abnormal sound, consult with your dealer.

### Maintenance and inspection

- If the air conditioner is used throughout several seasons, the insides can get dirty, reducing the performance.

Depending upon the conditions of usage, foul odors can be generated and drainage can deteriorate due to dust and dirt, etc.

## 8. Specifications

|                  |                          | Ceiling concealed type (Refrigerant R22) |                    |           |           |                    |           |             |              |  |  |
|------------------|--------------------------|--|--------------------|-----------|-----------|--------------------|-----------|-------------|--------------|--|--|
| Cooling capacity | Gross                    | kW                                       | 14.6               | 17.5      | 23.4      | 29.3               | 33.5      | 46.8        | 58.6         |  |  |
|                  | Net                      | kW                                       | 13.8               | 16.7      | 22.5      | 28.4               | 32.3      | 45.4        | 56.1         |  |  |
| Indoor unit      | Model name               |  | PE-5 MYE           | PE-6MYE   | PE-8MYE   | PE-10MYE           | PE-12MYE  | PE-16MYE    | PE-20MYE     |  |  |
|                  | Power supply             | Voltage                                  | ~ 220, 230, 240    |           |           | 3N ~ 380, 400, 415 |           |             |              |  |  |
|                  |                          | Frequency                                | 50                 |           |           |                    |           |             |              |  |  |
|                  | External static pressure | Pa                                       | 100                |           |           |                    | 150       |             |              |  |  |
|                  | Airflow rate (Hi/Lo)     | m³/h                                     | 3000/2400          | 3300/2640 | 3900/3120 | 4800/3840          | 5700/4560 | 7200        | 9300         |  |  |
|                  | Noise level (Hi/Lo)      | dB(A)                                    | 46/42              | 49/45     |           | 50/46              | 50/48     | 52          | 53           |  |  |
|                  | Dimension                | Height                                   | mm                 | 400       |           |                    | 428       | 595         |              |  |  |
|                  |                          | Width                                    | mm                 | 1180      |           | 1400               | 1600      | 1580        | 1947         |  |  |
|                  |                          | Depth                                    | mm                 | 634       |           |                    | 650       | 764         |              |  |  |
| Net weight       | kg                       | 56                                       | 59                 | 70        | 77        | 82                 | 130       | 133         |              |  |  |
| Outdoor unit     | Model name               |  | PU-5 MYG           | PU-6MYG   | PU-8MYG   | PU-10MYG           | PU-12MYG  | PU-8MYG × 2 | PU-10MYG × 2 |  |  |
|                  | Power supply             | Voltage                                  | 3N ~ 380, 400, 415 |           |           |                    |           |             |              |  |  |
|                  |                          | Frequency                                | 50                 |           |           |                    |           |             |              |  |  |
|                  | Airflow rate (Hi/Lo)     | m³/h                                     | 4800               |           |           | 9600               |           |             |              |  |  |
|                  | Noise level (Hi/Lo)      | dB(A)                                    | 61                 | 62        | 66        |                    |           |             |              |  |  |
|                  | Dimension                | Height                                   | mm                 | 1000      |           |                    | 1480      |             |              |  |  |
|                  |                          | Width                                    | mm                 | 1047      |           |                    |           |             |              |  |  |
|                  |                          | Depth                                    | mm                 | 547       |           |                    |           |             |              |  |  |
| Net weight       | kg                       | 136                                      | 145                | 190       | 198       | 200                |           |             |              |  |  |

Notes: Refer to the product nameplate attached to the unit for the electrical specifications.

Rating conditions (cooling) Indoor: 27 °C DB, 19.5 °C WB Outdoor: 35 °C DB

---

Please be sure to put the contact address/telephone number on  
this manual before handing it to the customer.